

PKZ 0 Manual Motor Protectors and Motor Protector Combinations Dimensions

Manual motor protectors

PKZM0-...(+NHI-E-...PKZ0)
PKZM0-...T
PKM0-...

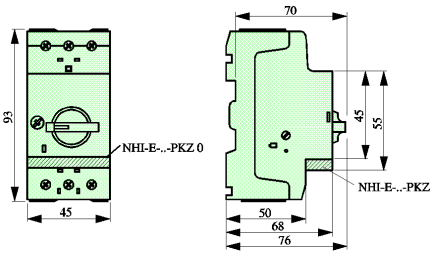

Manual self-protected motor controller

PKZM0-.../SP

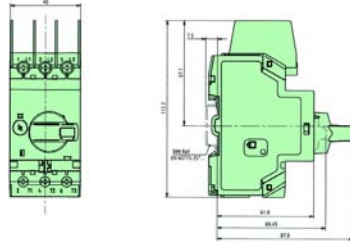

Manual motor protector with lockable rotary handle

PKZM0-... +AK-PKZ0

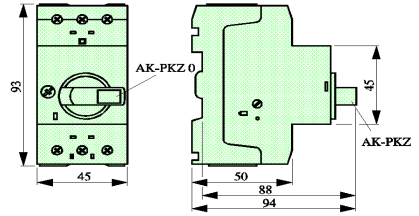

Current limiter

CL-PKZ

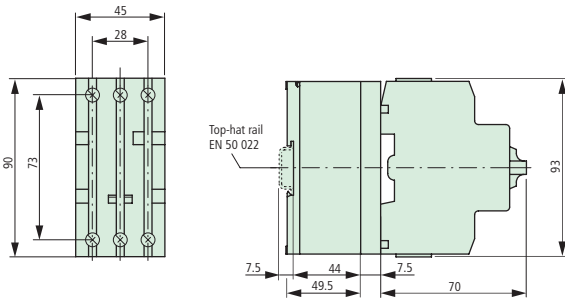

Manual motor protectors with early-make auxiliary contacts

PKZM0-...+VHI-...PKZ0

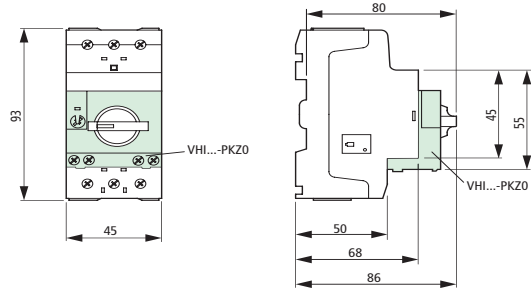

Magnetic motor protector combinations

PKZM0-.../S(E)00 (+NHI-E-...PKZ0)

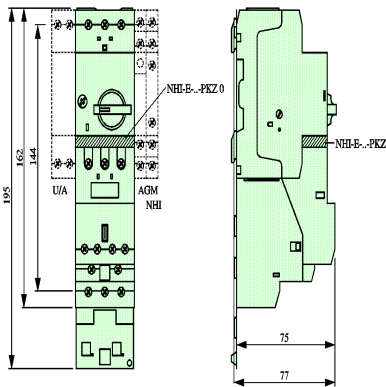

Standard auxiliary contacts for motor protector combination

NHI 2-11S-PKZ0

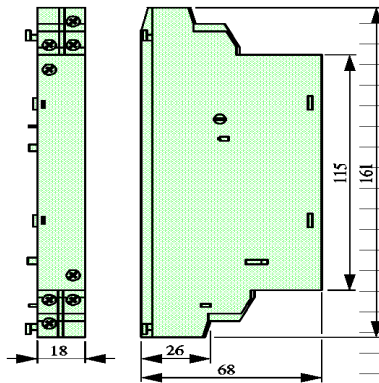

Standard auxiliary contacts

NHI...-PKZ0

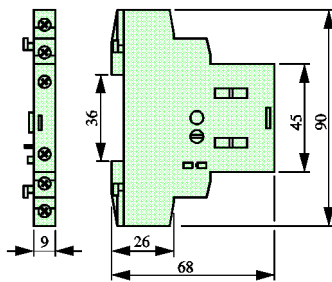

Trip-indicating auxiliary contacts

AGM2-...-PKZ0

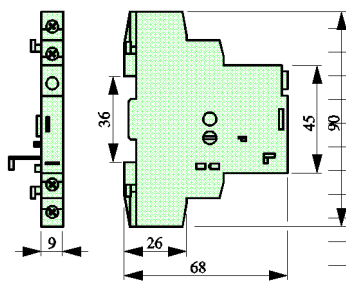

Voltage trips

U/A-PKZ0

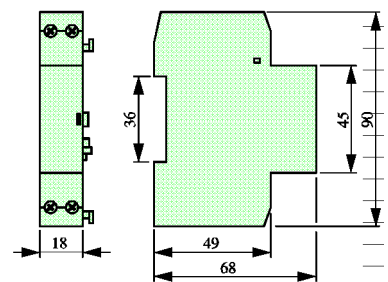

PKZ 0 Manual Motor Protectors and Motor Protector Combinations Dimensions

Magnetic contactor modules

S(E)00-PKZ0

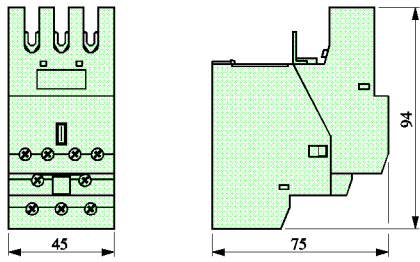

Separate mounting

EZ-PKZ0

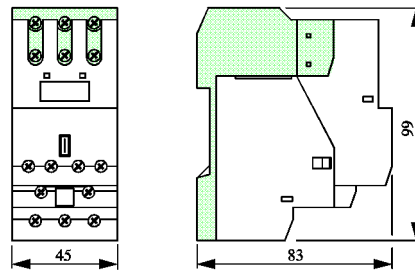

Auxiliary contacts for magnetic contactor modules

HI11-S/EZ-PKZ0

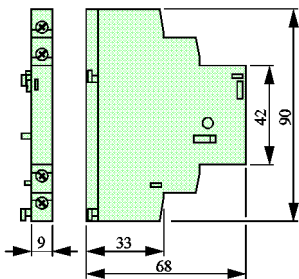

Mechanical interlocks

MV-PKZ0

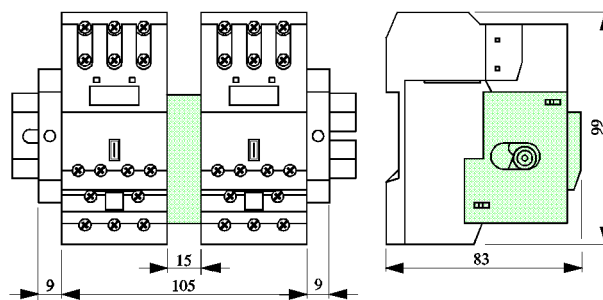

Three-phase feeder bus connectors

B3.0/4-PKZ0
B3.0/2-PKZ0

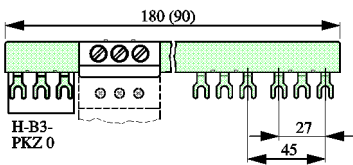

B3.2/4-PKZ0
B3.2/2-PKZ0

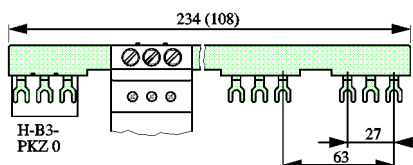

Three-phase feeder bus connectors

B3.1/5-PKZ0
B3.1/4-PKZ0
B3.1/3-PKZ0
B3.1/2-PKZ0

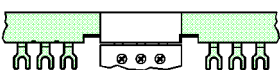
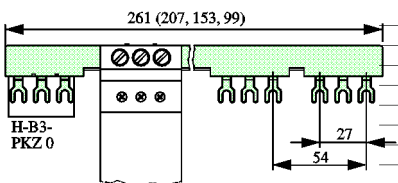

Use overlapping mounting to extend three-phase feeder bus connections

Terminals

BK25/3-PKZ0

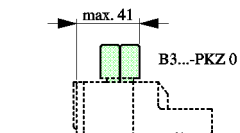
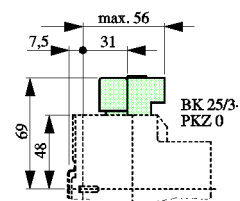

Cover for unused terminals

H-B3-PKZ0

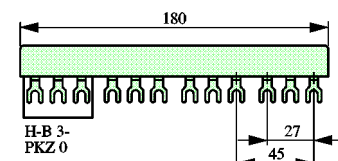

PKZ 0 Manual Motor Protectors Dimensions

Insulated enclosures for surface mounting

CI-K2-PKZ0-NA

CI-K2-PKZ0-G(R)(V)-NA

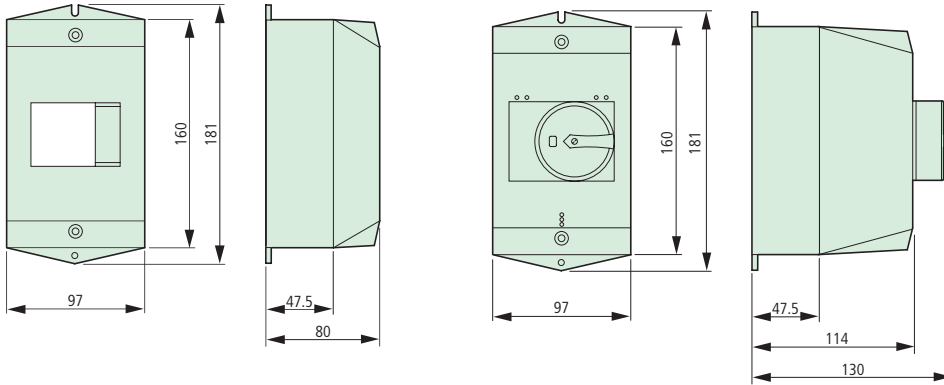

Insulated enclosures for surface mounting

CI23X-125-NA

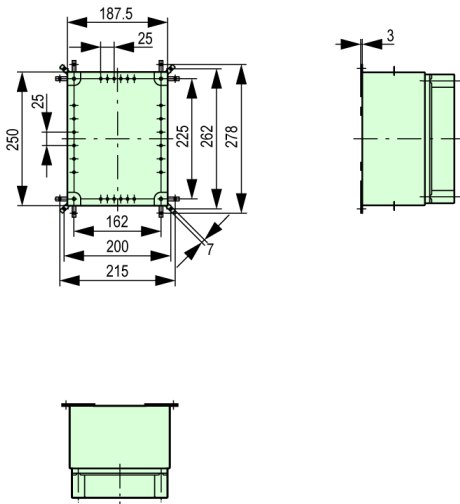

Door coupling handles

(R)H-PKZ0, HSOV-PKZ0

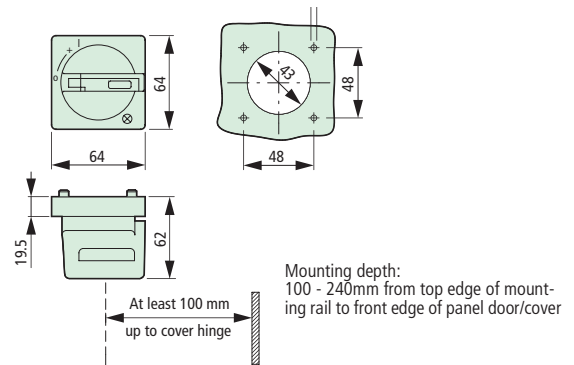

Mounting plate

M3-CI23

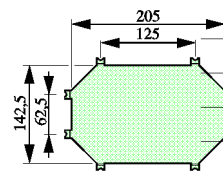

PKZ 0 Manual Motor Protectors and Motor Protector Combinations Dimensions

Insulated enclosures for flush mounting

E-PKZO
E-PKZO-G(R)

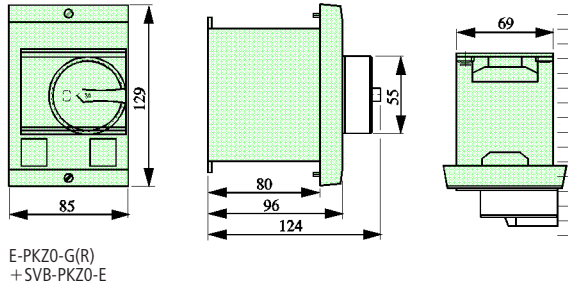

E-PKZO-G(R)
+ SVB-PKZO-E

Mounting opening
E-PKZO...

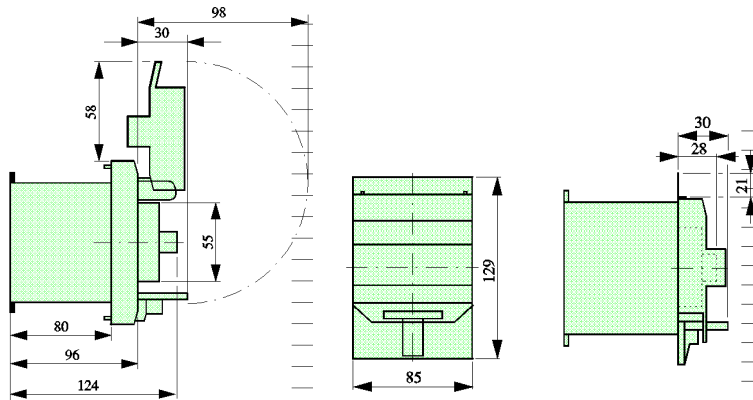
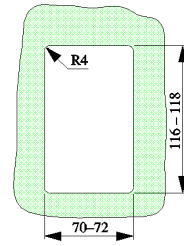

Component adapters

AD25/5(10)-1

AD25/5(10)-2

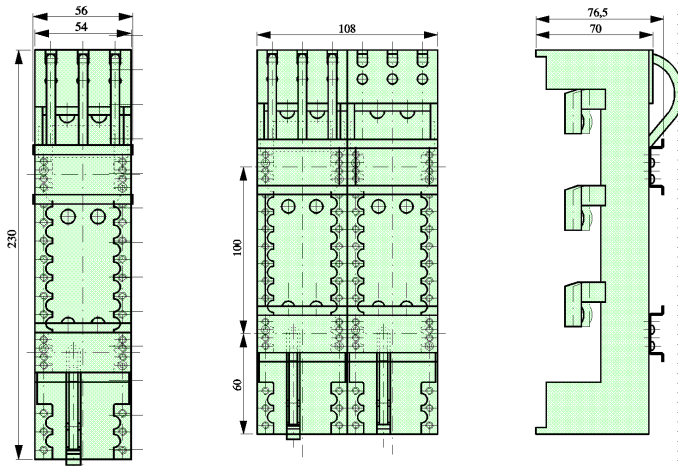

AD25/5(10)-144

