

DIL Contactors Dimensions

Mini contactors

DIL E(E)M...(-C)
DILE(E)M...-G(-C)

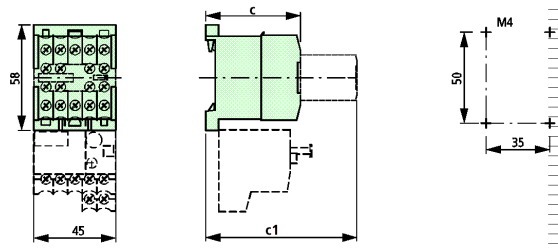

| | DILE(E)M(-G) | DILE(EM)(-G)-C |
|----|--------------|----------------|
| c | 52 | 54 |
| c1 | 83 | 86 |

Contactors

DIL 00 M(-G) to DIL 2 AM(-G)

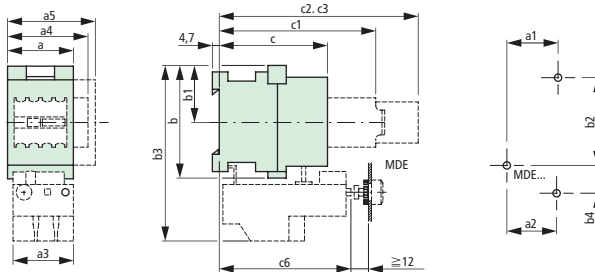

| 2 M4 × 16 | 2 M5 × 16 |
|-------------|------------|
| DIL 00 (A)M | DIL 1 (A)M |
| DIL 0 (A)M | DIL 2 (A)M |

| DIL | 00 M -G 00 AM -G 00 M 4 -G | 00M-C -G-C 00AM- -G-C C | 0 M (-G) 0 AM (-G) | 1 M (-G) 1 AM (-G) | 2 M (-G) 2 AM (-G) |
|-------------------|----------------------------------|-------------------------------|-----------------------|-----------------------|-----------------------|
| a | 45 | 45 | 45 (45) | 60 (60) | 70 (70) |
| a1 | 35 | 35 | 35 (35) | 50 (50) | 60 (60) |
| a4 | - | - | 55 (55) | 70 (70) | 80 (80) |
| a5 | - | - | 60 (60) | 80 (80) | 90 (90) |
| b | 77 | 77 | 83 (83) | 98 (98) | 118 (118) |
| b1 | 39 | 39 | 41.5 (41.5) | 49 (49) | 59 (59) |
| b2 | 60 | 60 | 60 (60) | 75 (75) | 90 (90) |
| c (without H DIL) | 74 | 99 | 74 (74) | 99 (99) | 102 (102) |
| c (with H DIL) | 76,5 | 101,5 | - | 86,3 (113,3) | - |
| c1 | 107 | 132 | 107 (107) | 132 (132) | 135 (135) |
| c2 | 136 | 161 | 136 (136) | 161 (161) | 164 (164) |
| c3 | 136 | 161 | 137 (137) | 162 (162) | - |

Overload relays

| Z | 00 | 00 | 1 | 1 |
|----|-----------|----|-----------|-----------|
| a2 | 34 (34) | - | 34 (34) | 42 (42) |
| a3 | 45 (45) | - | 45 (45) | 60 (60) |
| b3 | 120 (120) | - | 133 (133) | 153 (153) |
| b4 | 19 (19) | - | 18 (18) | 26 (26) |
| c6 | 90 (115) | - | 96 (121) | 91 (116) |

Maintain a minimum spacing of 5 mm between DC operated DIL00M-G(-C) to DIL2AM-G contactors mounted side by side.

- a4 = with side mounted auxiliary contact module on DIL 0M to DIL 2 AM,
- a5 = with N DIL...M 4th pole module
- c1 = with ...DIL M auxiliary contact module
- c2 = with TP...11 DIL pneumatic timer module
- c3 = with V(-G) DIL mechanical latching module

DIL 3M80
DIL 4M115
DIL 3MK72

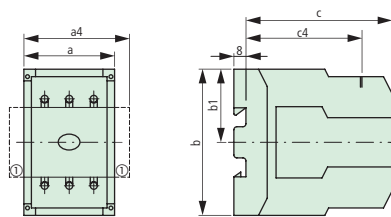

| | |
|--------------|-----------|
| DIL 3M80 | 2 M5 × 20 |
| Z 5-.../SK 3 | 2 M5 × 20 |
| DIL 4M115 | 2 M6 × 20 |
| Z 5-.../SK 4 | 2 M6 × 20 |

DIL 3M80 + Z5-.../SK3
DIL 4M115 + Z5-.../SK4

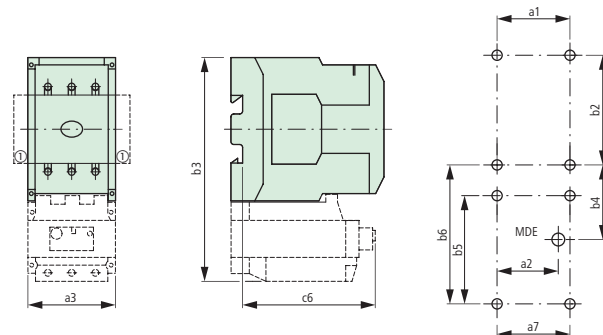

| DIL | 3 M80 3 MK72 | 4 M115 |
|-----|-----------------|--------|
| a | 100 | 120 |
| a1 | 80 | 100 |
| a4 | 112 | 130 |
| b | 130 | 150 |
| b1 | 65 | 75 |
| b2 | 110 | 130 |
| c | 127 | 137 |
| c4 | 77 | 79 |

Overload relay

| Z | 5-.../SK 3 | 5-.../SK 4 |
|----|------------|------------|
| a2 | 57 | 67 |
| a3 | 100 | 120 |
| a7 | 80 | 80 |
| b3 | 238 | 263 |
| b4 | 51 | 56 |
| b5 | 74 | 74 |
| b6 | 95 | 100 |
| c6 | 125 | 125 |

a4 = with second side mounted auxiliary contact module
DIL M 820-XH111-SA on DIL 3M80 to DIL 4M115

DIL Contactors

Dimensions

Contactors

DIL M 185
DIL M 225
DIL M 250

DIL M 300
DIL M 400
DIL M 500

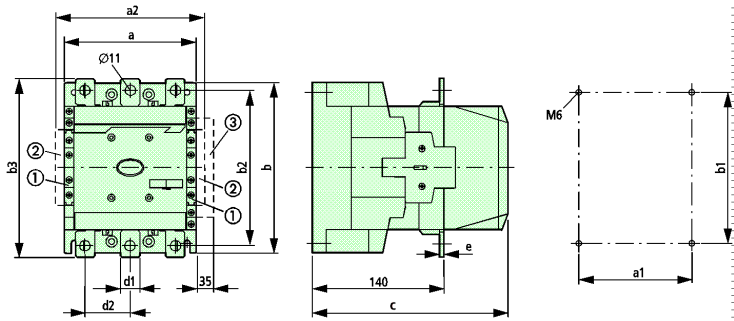

- ① DIL M 820-XHI...-SI
- ② DIL M 820-XHI11-SA
- ③ DIL M ...-XMV

| DIL | M 185 | M 225 | M 250 | M 300 | M 400 | M 500 |
|-----|-------|-------|-------|-------|-------|-------|
| a | 140 | 140 | 140 | 160 | 160 | 160 |
| a1 | 120 | 120 | 120 | 130 | 130 | 130 |
| a2 | 160 | 160 | 160 | 180 | 180 | 180 |
| b | 180 | 180 | 180 | 200 | 200 | 200 |
| b1 | 160 | 160 | 160 | 180 | 180 | 180 |
| b2 | 164 | 164 | 164 | 184 | 184 | 189 |
| b3 | 189 | 189 | 189 | 209 | 209 | 219 |
| d1 | 20 | 20 | 25 | 25 | 25 | 35 |
| d2 | 48 | 48 | 48 | 48 | 48 | 57 |
| e | 5 | 5 | 5 | 6 | 6 | 6 |
| c | 208 | 208 | 208 | 216 | 216 | 216 |

DIL M 580
DIL M 650

DIL M 750
DIL M 820

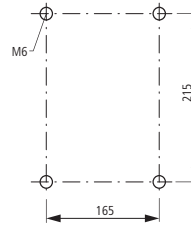
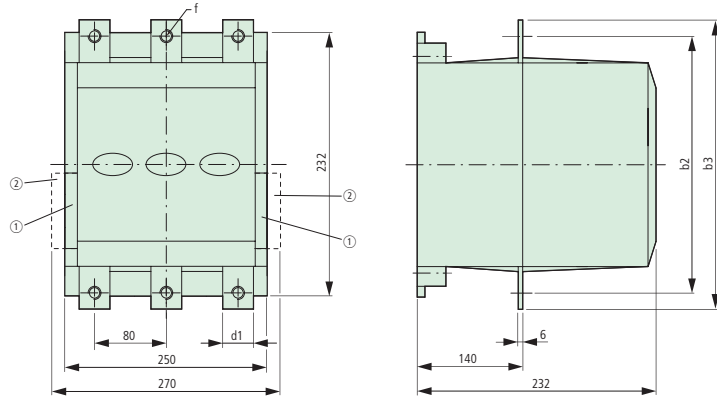

- ① DIL M 820-XHI...-SI
- ② DIL M 820-XHI11-SA
- ③ DIL M ...-XMV

| DIL | M 580 | M 650 | M 750 | M 820 |
|-----|-------|-------|-------|-------|
| b2 | 256 | 256 | 256 | 256 |
| b3 | 286 | 286 | 296 | 296 |
| d1 | 35 | 35 | 45 | 45 |
| f | 11 | 11 | 13,5 | 13,5 |

Contactors with terminal cover

DIL M 185 to DIL M 820 with DIL M...-XHB

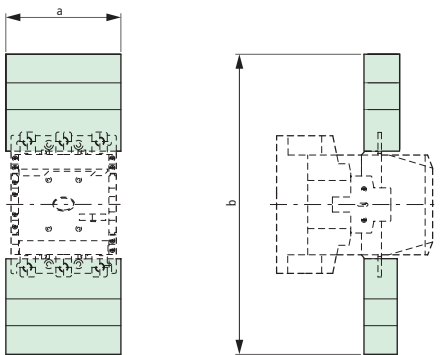

| | DIL M 185 DIL M 225 DIL M 250 DIL M 185-XP1 | DIL M 300 DIL M 400 | DIL M 500 | DIL M 580 DIL M 650 DIL M 750 DIL M 820 |
|---|--|------------------------|-----------|--|
| a | 150 | 150 | 174 | 236 |
| b | 384 | 404 | 369 | 506 |

DIL M 185 to DIL M 250 with Z5.../FF250

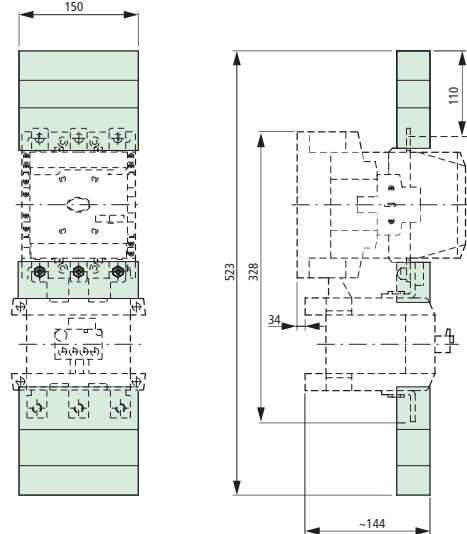

DIL Contactors

Dimensions

Contactor for three-phase capacitors with resistor

DIL00MK-11
DIL00MK-02
DIL0MK-10
DIL1MK-10
DIL2MK-10

DIL00MK-11
DIL00MK-02

DIL0MK-10
DIL1MK-10
DIL2MK-10

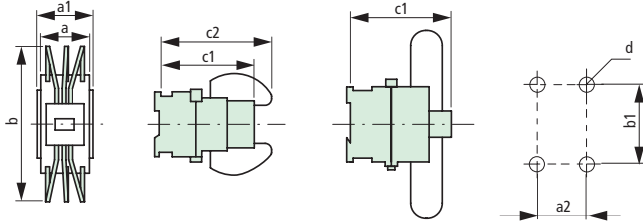

| DIL | 00MK-11(02) | 0MK-10 | 1MK-10 | 2MK-10 |
|-----|-------------|------------------|--------|--------|
| a | 45 | 45 | 60 | 70 |
| b | ~115 | ~165 | ~180 | ~190 |
| c1 | 109 | 114,5 | 132,5 | 137 |
| c2 | ~125 | - | - | - |
| | | with 2 × 01SDILM | | |
| a1 | - | 65 | 80 | 90 |
| a2 | 35 | 35 | 50 | 60 |
| b1 | 60 | 75 | 75 | 90 |
| d | M4 | M4 | M5 | M5 |

DIL Contactors

Dimensions

Contactors with star-delta bridge + terminal cover

DIL M...-XS1

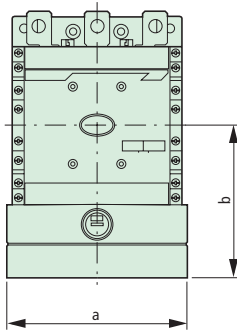

| DIL M | 185 – 250 | 300 – 400 | 500 |
|-------|-----------|-----------|-----|
| a | 150 | 150 | 176 |
| b | 127 | 137 | 146 |

Reversing starters

DIUL E(E)M

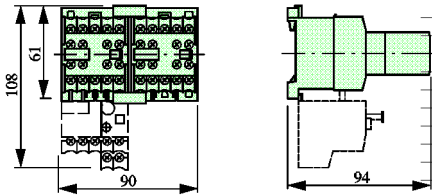

DIUL 00 AM/11 to DIUL 2 AM/11

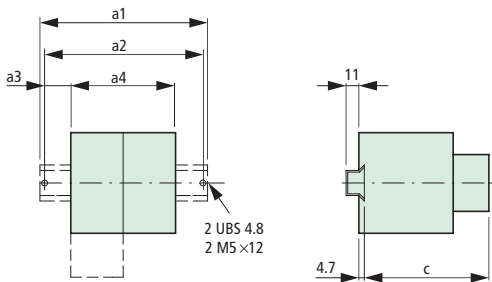

| DIUL | 00 AM | 0 M 0 AM | 1 AM | 2 M 2 AM |
|------|-------|-------------|------|-------------|
| a1 | 114 | 114 | 164 | 189 |
| a2 | 100 | 100 | 150 | 175 |
| a3 | 5 | 5 | 15 | 17,5 |
| a4 | 90 | 90 | 120 | 140 |
| c | 107 | 112 | 130 | 135 |

Note: Width increases by 15 mm for reversing contactors with mechanical interlock

DIUL 3M80/11 to DIUL 4M115/11

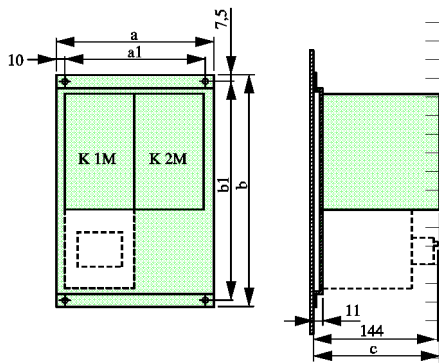

| DIUL | 3M80 | 4M115 |
|------|------|-------|
| a | 225 | 265 |
| a1 | 205 | 245 |
| b | 268 | 294 |
| b1 | 253 | 279 |
| c | 146 | 156 |

Note: Width increases by 10 mm for reversing contactors with mechanical interlock

Accessories Dimensions

Suppressors

RCDILE
VGDILE

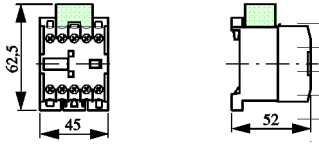

RCBDIL...
RCSLIL...
FDBDIL...
VGBDIL...
VGCDIL

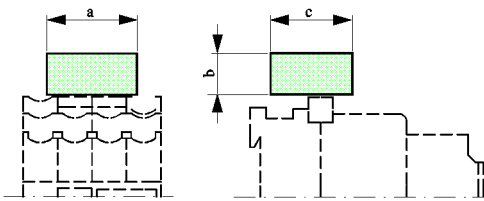

| | RCBDIL | RCSLIL | FDBDIL | VGBDIL | VGCDIL |
|---|--------|--------|--------|--------|--------|
| a | 33 | 33 | 33 | 33 | 38 |
| b | 15 | 15 | 15 | 15 | 8 |
| c | 30 | 30 | 30 | 30 | 33 |

Interface modules

VS 1 DIL
VS 2 DIL

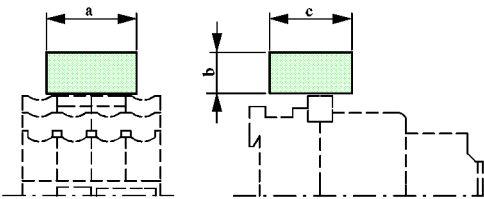

| | VS 1 DIL VS 2 DIL |
|---|----------------------|
| a | 45 |
| b | 26 |
| c | 55 |

ETS 4-VS 3

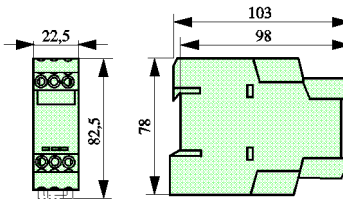

Star-point bridges

S1 DIL... M

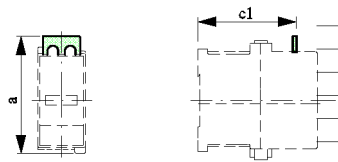

| S1 DIL | 00 M | 0 M | 1 M | 2 M | 3 M | 4 M |
|--------|------|-----|-----|-----|-----|-----|
| a | 77 | 91 | 106 | 126 | 150 | 169 |
| c1 | 65 | 69 | 79 | 79 | 92 | 93 |

Paralleling links

P 1 DIL EM

P1 DIL...M

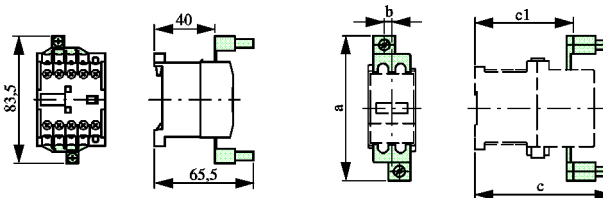

| for DIL | 00 (A)M(-G) | 0 (A)M(-G) | 1 (A)M(-G) | 2 (A)M(-G) | 3M80 | 4M115 |
|---------|-------------|------------|------------|------------|------|-------|
| a | 95 | 114 | 170 | 188 | 195 | 244 |
| b | 5 | - | 9 | 12 | 19 | 17 |
| c | 91 (116) | 103 (128) | 138 (163) | 138 (163) | 150 | 182 |
| c1 | 65 (90) | 69 (94) | 79 (101) | 79 (101) | 88 | 92 |

Accessories
Dimensions

Tamper-proof cover

H DIL E

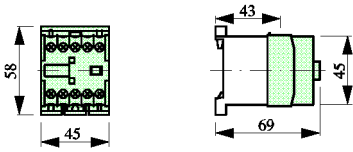

Adapter

AK DIL... M

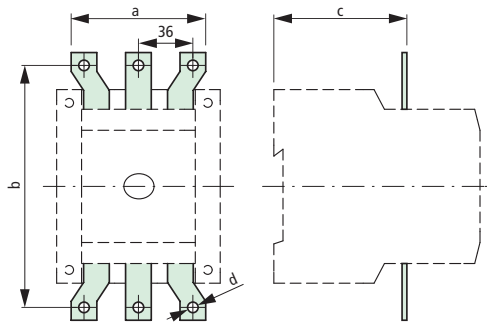

| for DIL | AK DIL... | |
|---------|-----------|-------|
| | 3M80 | 4M115 |
| a | 89 | 94 |
| b | 160 | 190 |
| c | 88 | 91 |
| d | 7 | 8,4 |

Extension terminals

ZK DIL 0 M
ZK DIL M

ZK DIL 1 M
HK DIL M

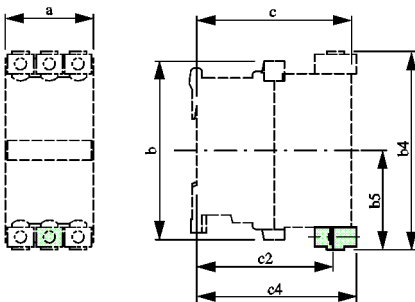

| for DIL | ZK DIL 0 M | | ZK DIL 1 M | | | | ZK DIL M | |
|-------------------------|------------|---------|------------|---------|--------|---------|----------|-------|
| | 0 (A)M | (-G) | 1 (A)M | (-G) | 2 (A)M | (-G) | 3M80 | 4M115 |
| a | 45 | (45) | 60 | (60) | 70 | (70) | 100 | 120 |
| b | 91 | (91) | 98 | (98) | 118 | (118) | - | - |
| b4 | 101 | (101) | 98 | (98) | 112,5 | (112,5) | 136 | 166 |
| b5 | 50,5 | (50,5) | 49 | (49) | 56,3 | (56,3) | 68 | 83 |
| c | 79 | (104) | 97 | (122) | 102 | (127) | 127 | 137 |
| c2 (max. with HK DIL M) | 69,5 | (94,5) | 80,5 | (105,5) | 80,5 | (105,5) | 102 | 105 |
| c4 (max. with HK DIL M) | 81,5 | (106,5) | 92,5 | (117,5) | 92,5 | (117,5) | 118 | 121 |

| for DIL | HK DIL M | | | |
|---------|----------|---------|-------|---------|
| | 1(A)M | (-G) | 2(A)M | (-G) |
| a | 60 | (60) | 70 | (70) |
| b | 98 | (98) | 118 | (118) |
| b4 | 104,5 | (104,5) | 123 | (123) |
| b5 | 52,3 | (52,3) | 61,5 | (61,5) |
| c | 97 | (122) | 102 | (127) |
| c2 | 73,5 | (98,5) | 74,2 | (99,2) |
| c4 | 107,4 | (132,4) | 107,7 | (132,7) |

Accessories Dimensions

Mechanical interlock

MV DIL E

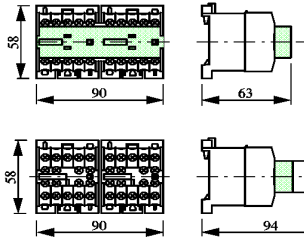

MV DIL M
DIL M 500-XMV

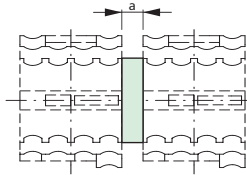

| | | | |
|---|--------------------------------------|----------------------|------------------------------|
| | DIL... 00 M(-G) to 2 AM(-G) | 3 M80 to 4M115 | DIL M 185 to DIL M 500 |
| a | 15 | 10 | 15 |

DILM820-XMV

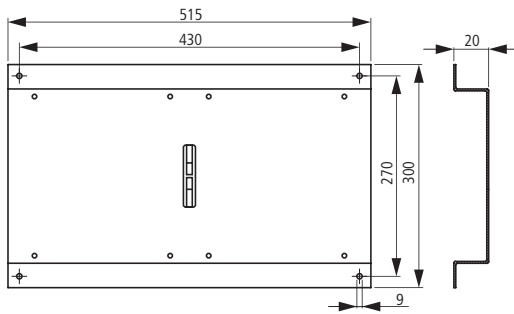

Wire terminal block

DIL M...-XKU-S

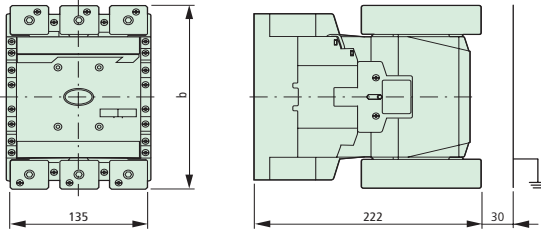

| | | | |
|-----------|---------|-----|---------|
| for DIL M | 185-225 | 250 | 300-400 |
| b | 198 | 198 | 218 |

Flat strip conductor terminals

DIL M...-XKB-S

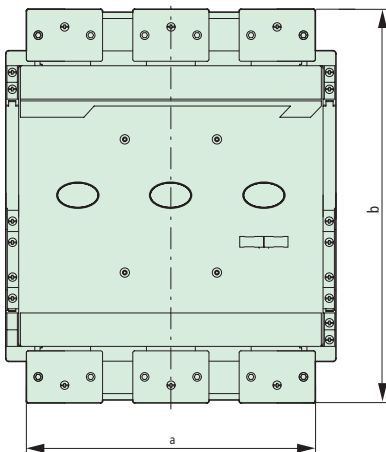

| | | | |
|-----------|-----|---------|---------|
| for DIL M | 500 | 580-650 | 750-820 |
| a | 171 | 218 | 231 |
| b | 232 | 295 | 310 |